

W90600B

Waveguide Tuner (60-90GHz)

General

Since 1989 Focus Microwaves manufactures waveguide programmable (slide screw) impedance tuners. Starting with models from 26 to 40 GHz and now up to 330 GHz using standard WR-3, WR-5, WR-6, WR-10, WR-12, WR-15, WR-22 and WR-28 waveguide sections. The extreme high horizontal (2.5µm) and vertical (1.5µm) probe movement resolution allows dense impedance coverage up to the highest frequency. Focus' series of waveguide tuners provide high tuning range in a small footprint, making them ideal for on-wafer applications. Multiple models are available for Ka, V, E, W and D bands.

The extreme low loss RF probes used in the waveguide tuners are also designed for optimal tuning accuracy and repeatability and are free of spurious resonances. All Focus tuners are LAN controlled and include on-board impedance synthesis firmware (iTuner) based on previous calibration.

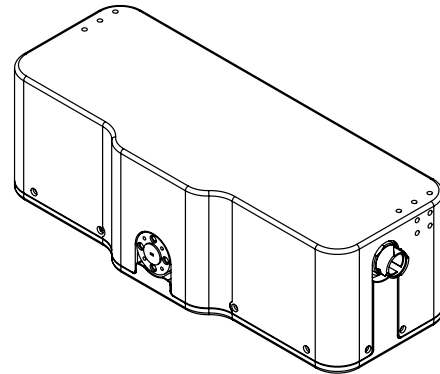

Model	Freq. Range (GHz)	Connector Type	VSWR (minimum)	Maximum Power* (W, CW)	Repeatability (min, dB/ typical, dB)	Length (in)
W90600B	60 - 90	WR-12	≥20:1	20	-40/-50	3.070

Tuner type for On-Wafer Applications

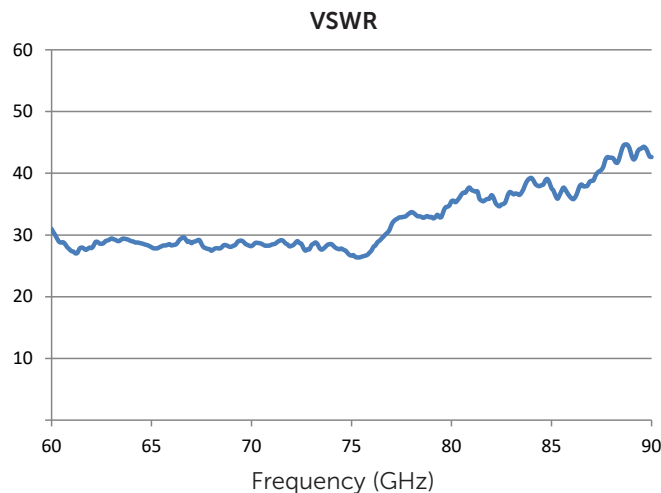

Dimensions

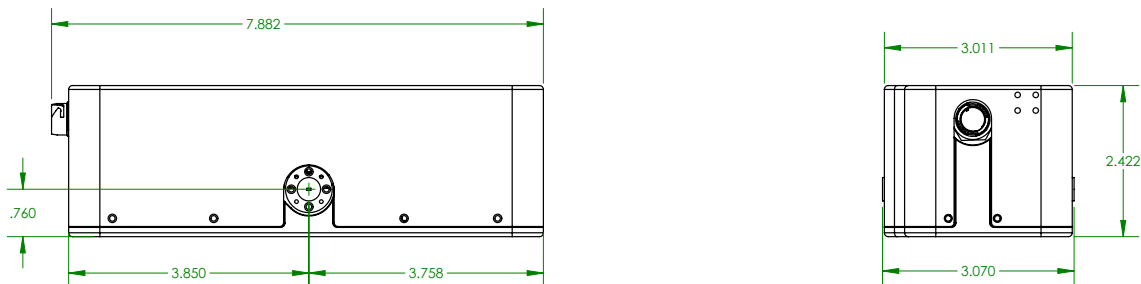

*measured at 10:1 VSWR