

# MMT-304 (0.4-3 GHz)

## Manual Microwave Tuner

### General

The Focus manual wideband and harmonic microwave tuners use the same RF technology and precision as automatic tuners, but at a considerably lower cost.

MMT's are available in octave and multi-octave bands between 0.4 and 50 GHz; MMT's are highly reliable and provide high VSWR at DUT reference plane. MMT's are available with harmonic tuning as well (option -H2 and -H23) using a similar concept as Focus' harmonic rejection tuners (PHT). Now available with digital display option.

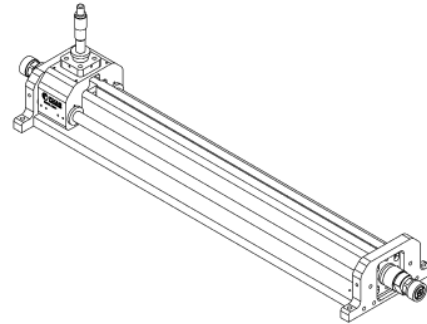

Model	Freq. Range (GHz)	Connector Type	VSWR (min/typical)	Length (in)
MMT-304	0.4 - 3.0	7/16, N, APC-7	10:1 / 25:1	24.646

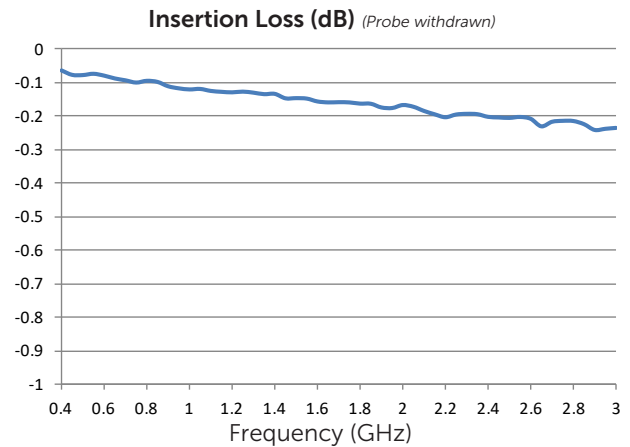
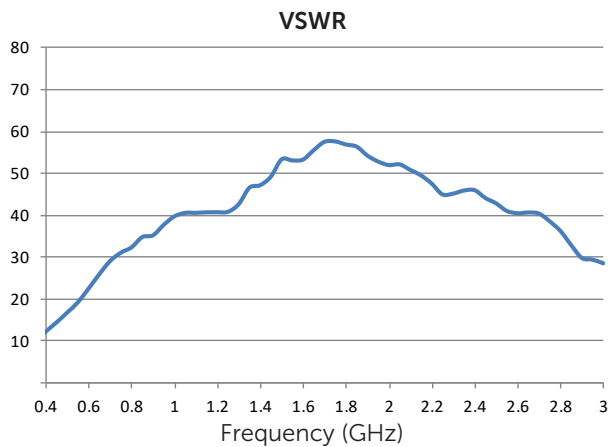

### Dimensions

