

MPT-Lite-1218 (1.8-12GHz)

Multi-Purpose Tuner

General

The MPT is Focus' flagship tuner. Its performance is unmatched and its capabilities make it the most popular tuner on the market today. Multi-purpose tuners (MPT) use three wideband probes, allowing independent control of the amplitude and phase of the reflection factor at all three harmonic frequencies simultaneously. The MPT is widely used for advanced applications like high power/efficiency RF amplifier design. By controlling the harmonic impedances with an accuracy of >40dB at the source and load, users can generate more robust behaviour models and have better insight on how their device performs in all classes of operation. The MPT can be used to pre-match impedances at the fundamental and the harmonic frequencies making it ideal for hybrid active systems, reducing the power needed to drive the load of high power devices. MPT-Lite tuners use two probes and control the fundamental and one harmonic frequency (2Fo or 3Fo).

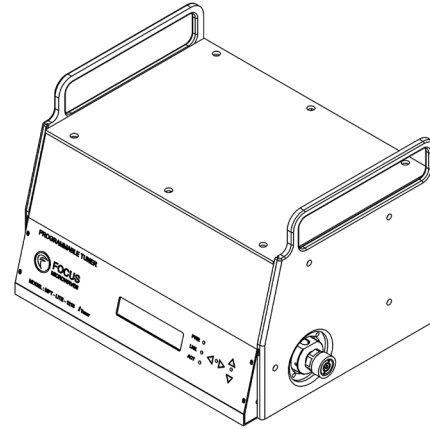

Model	Freq. Range (GHz)	Connector Type	VSWR		Maximum Power** (W, CW)	Repeatability (min, dB/ typical, dB)	Weight (lbs)	Length (in)
			High VSWR*	Harmonic tuning				
MPT-Lite-1218	1.8 - 12	N, APC-7	65:1	10:1-100:1	521	-40/-50	20.0	13.867

Harmonic tuning*

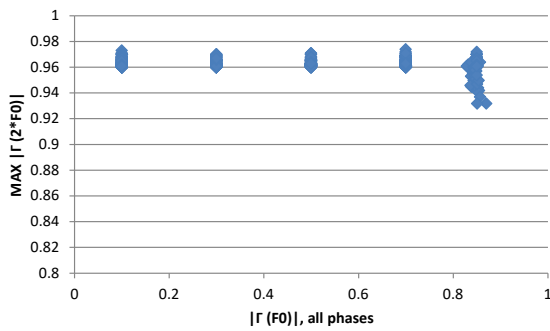

High VSWR tuning*

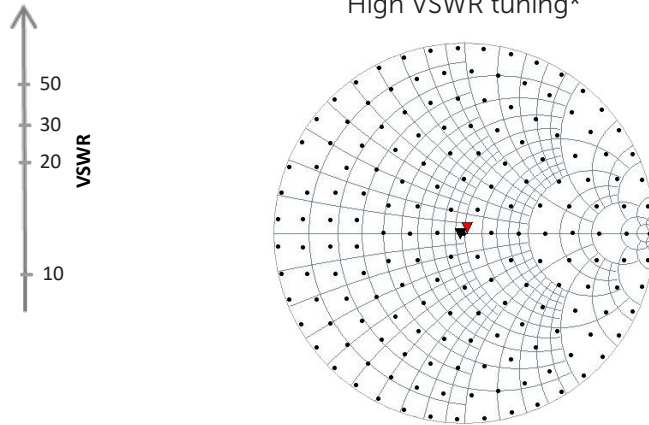

*measured at F0 = 1.8GHz

Dimensions

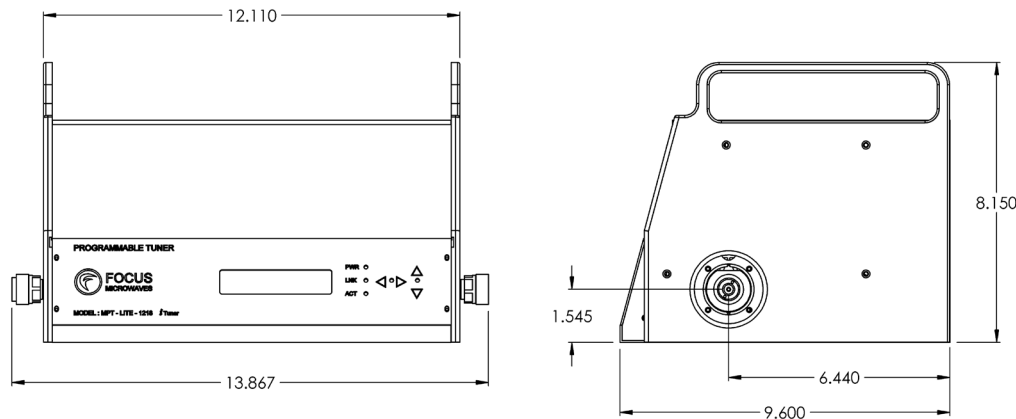

**at 12GHz (connector limited)

