

LFT-008004 (40-80 MHz)

Low Frequency Tuner

General

The LFT is a unique product technology using MPT algorithms for low frequency wideband tuning. Three or more cascaded tuning sections use series transmission cables and parallel rotary capacitors.

The length of the cables and number of tuning sections are optimized for maximum tuning range over a given bandwidth. HLFT tuners use 6 tuning sections allowing second harmonic frequency tuning.

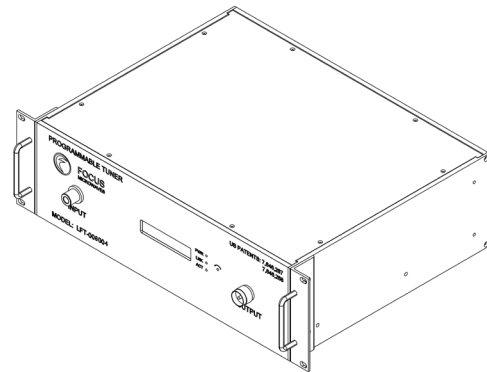

Model	Freq. Range (MHz)	Connector Type	VSWR (min/typical)	Power Handling** (W, CW)	Repeatability (min, dB/ typical, dB)	Weight (lbs)	Length (in)
LFT-008004	40 - 80	7/16, N	10:1/15:1	1000	-40/-50	20.0	13.00

Insertion/Return Loss [dB] (Tuner initialized)

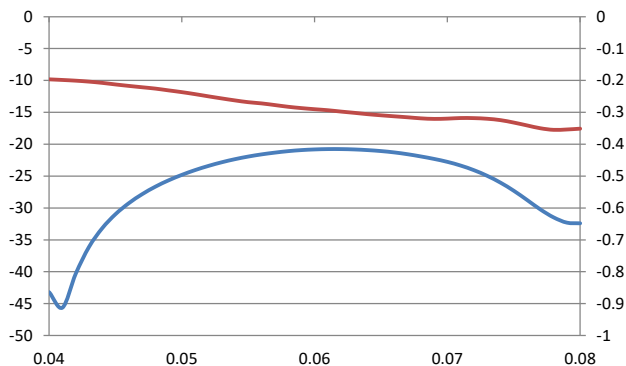

Typical Point Distribution*

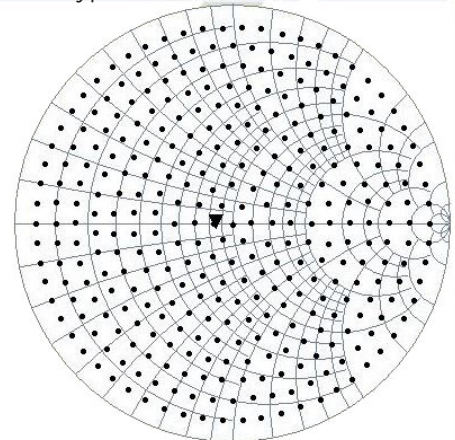

*measured at F0 = 55MHz

Dimensions

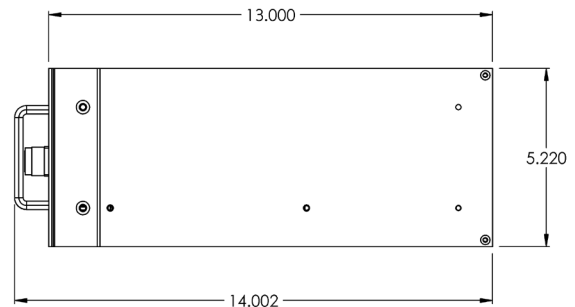
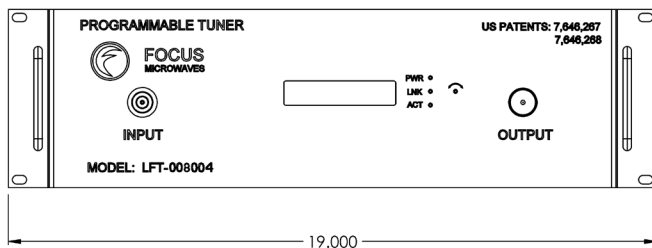

**measured at 3:1 VSWR

