

CCMT-4020 (2-40 GHz)

Computer Controlled Microwave Tuner

General

Since 1989 Focus Microwaves manufactures wideband coaxial programmable (slide screw) impedance tuners from 100MHz up to 67GHz. Focus' fundamental tuners were designed with versatility in mind. The CCMT (Computer Controlled Microwave Tuner) family of tuners have one to three wideband probes enabling very wideband frequency coverage making it ideal for high power applications as well as wideband noise applications.

The very long lasting RF probes used in the tuner are also designed for optimal tuning accuracy, free of spurious resonances. The combination of multiple probes provide ultra wideband coverage in one single tuner. All Focus tuners are LAN controlled and include on-board impedance synthesis firmware (iTuner).

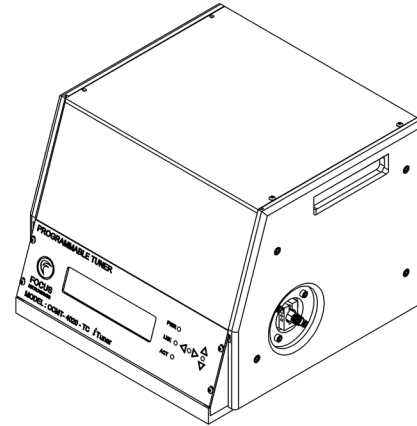

Model	Freq. Range (GHz)	Connector Type	VSWR (min/typical)	Maximum Power* (W, CW)	Repeatability (min, dB/ typical, dB)	Weight (lbs)	Length (in)
CCMT-4020	2 - 40	2.92mm	≥10:1/13:1	20	-40/-50	12.2	8.5

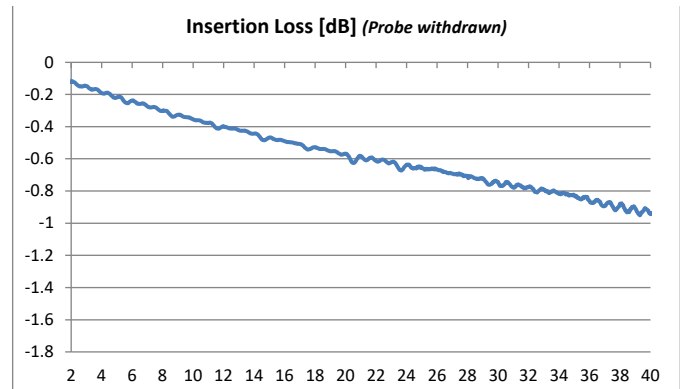
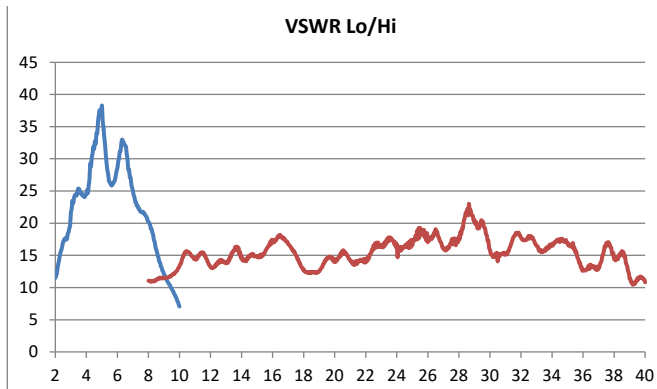

Dimensions

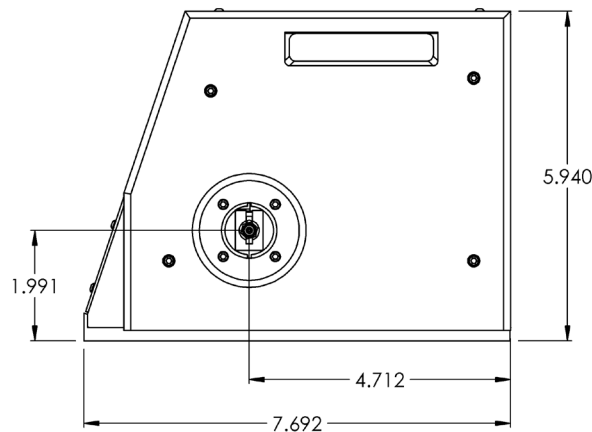
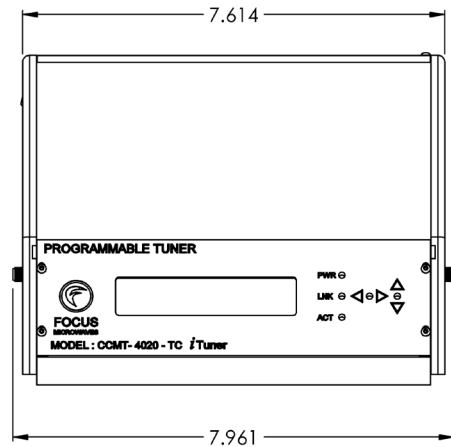

*at 40GHz (connector limited)

